

List of Parts—Machines Nos. 603E-11, 603E-14 and 603E-16

ATTACHMENT SET 161796 (Early Model)

21412	Spool Pin
21906	Loop Retainer Disc
21913	Throat Plate
81200	Binder
161133	Tube of Oil
161166	Zipper Foot
161168	Button Foot
161172	Seam Guide
161195	Hemmer Foot
161276	Lint Brush
161821	Attachment Box
163131	Bobbin (2)
163455	Thread Guide
163483	Special Purpose Foot
170071-001	Presser Foot
172185	Fashion Disc 1
172187	Fashion Disc 2
172190	Fashion Disc 4
172191	Fashion Disc 5
174527	Fashion Disc 9
174528	Fashion Disc 8
174529	Throat Plate
174533	Fashion Disc 10
17453Y	Fashion Disc 18
2020(15x1)	Needles 14 (3) 16 (3)

ATTACHMENT SET 161819

21906	Loop Retainer Disc
21913	Throat Plate
81200	Binder
161133	Tube of Oil
161166	Zipper Foot
161168	Button Foot
161172	Seam Guide
161195	Hemmer Foot
161276	Lint Brush
161821	Attachment Box
163131	Bobbin (2)
163242	Spool Pin
163455	Thread Guide
163483	Special Purpose Foot
170071-001	Presser Foot
172185	Fashion Disc 1
172187	Fashion Disc 2
172190	Fashion Disc 4
172191	Fashion Disc 5
174527	Fashion Disc 9
174526	Fashion Disc 8
174529	Throat Plate
174533	Fashion Disc 10
174536	Fashion Disc 10
2020(15x1)	Needles 14 (3) 16 (3)

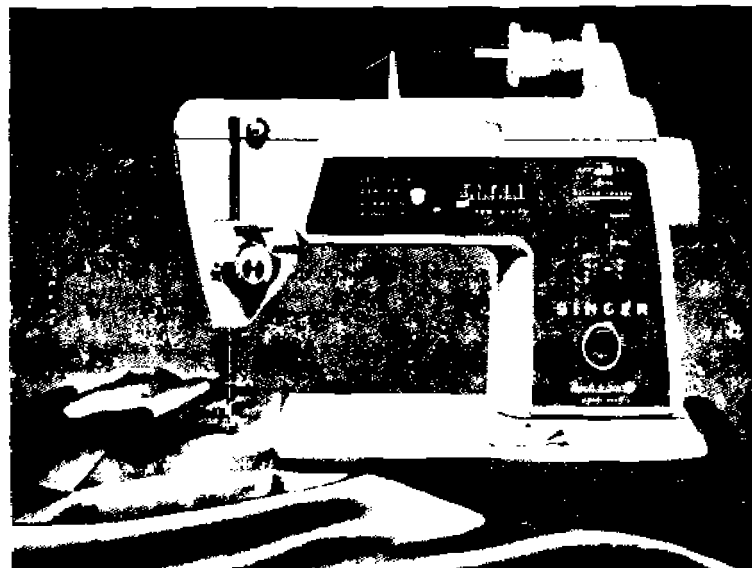

List of Parts—Machines Nos. 603E-11, 603E-14 and 603E-16

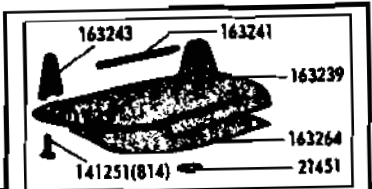
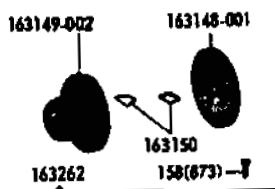

NOTE: Set of Mated Gears or Individual Gears are not furnished. Supplied only when repairs are made at the factory.

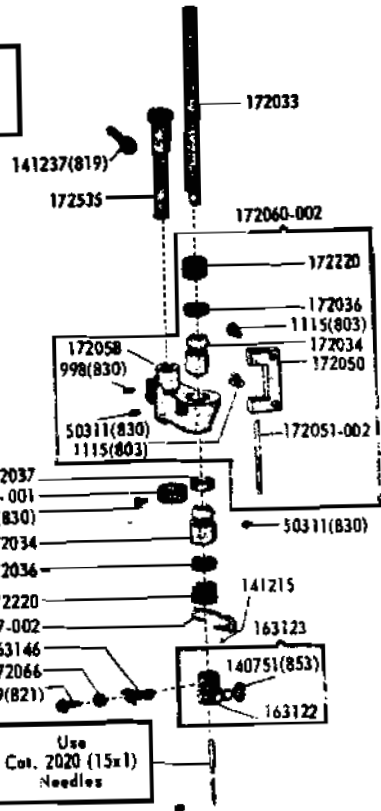
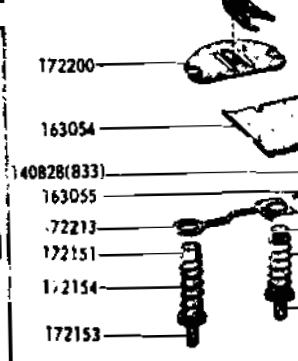
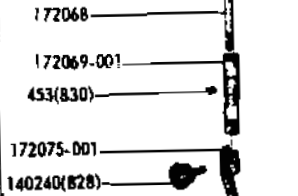
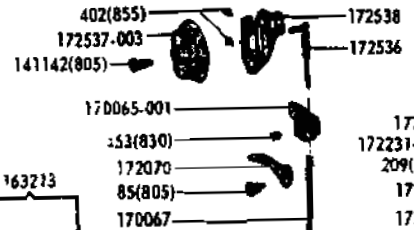
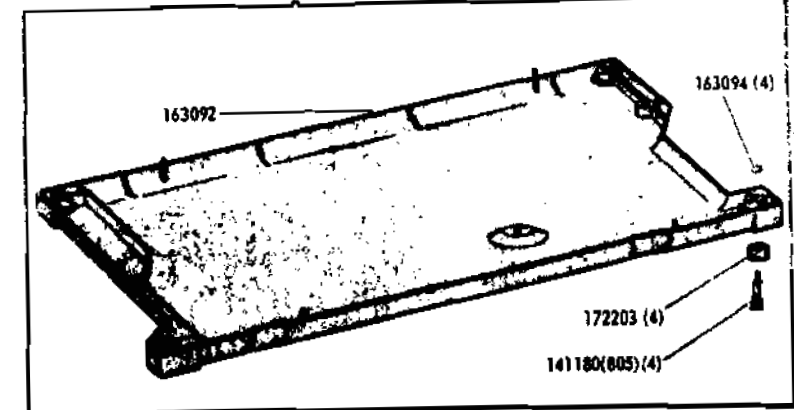
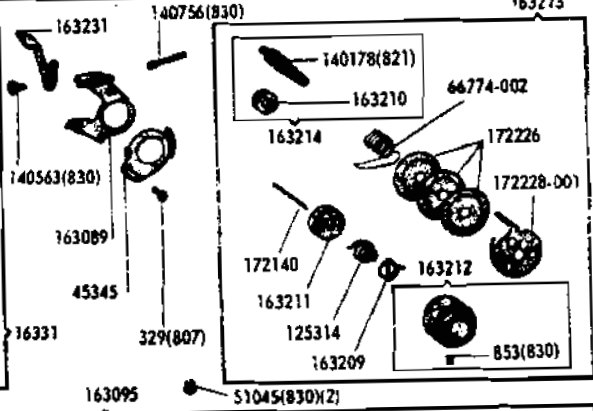
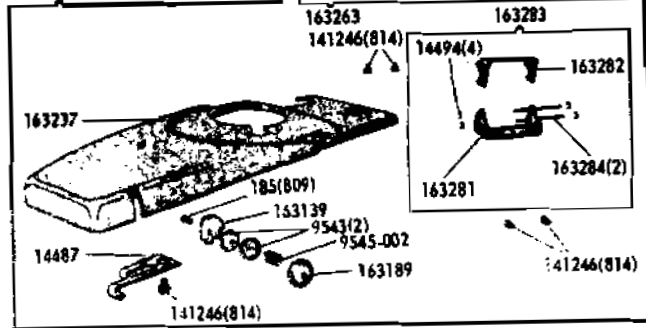

Use Cot. 2020 (15x1) Needles

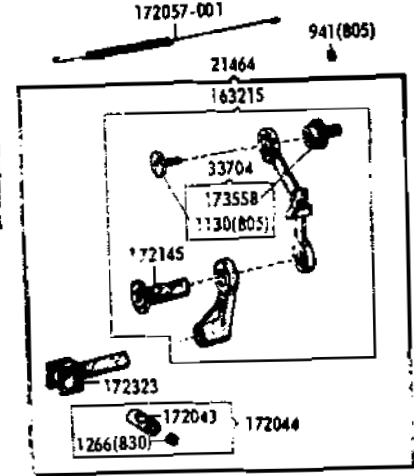
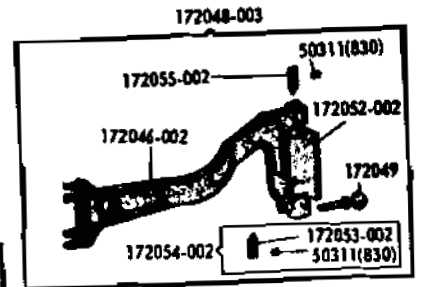
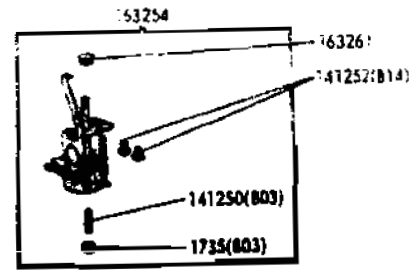
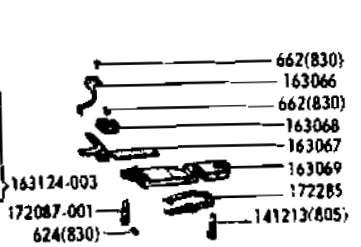
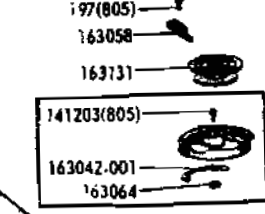

List of Parts—Machines Nos. 603E-11, 603E-14 and 603E-16

NOTE: Set of Mated Gears or Individual Gears are not furnished. Supplied only when repairs are made at the factory.

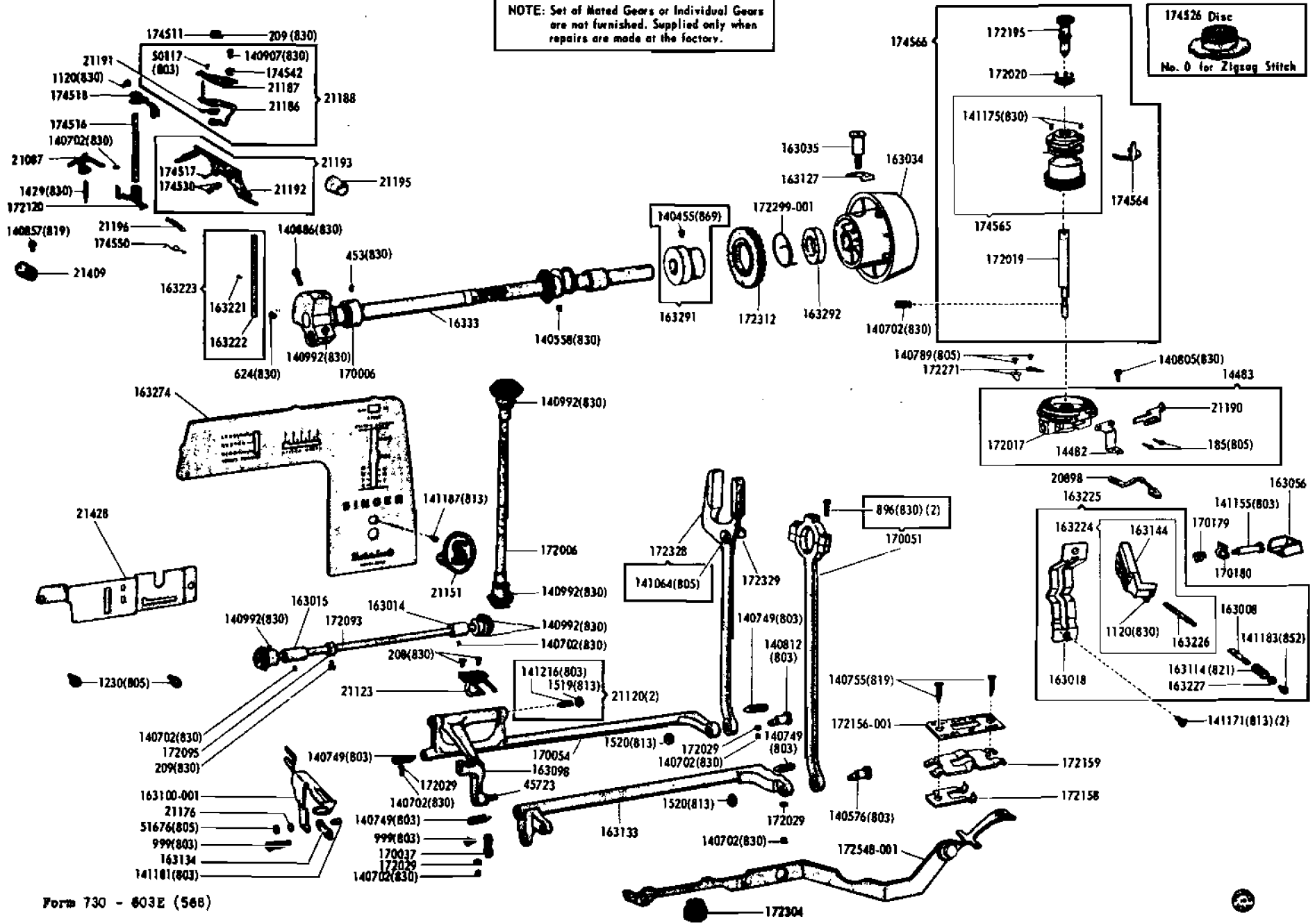

Electrical Parts

Machine No. 603E-11

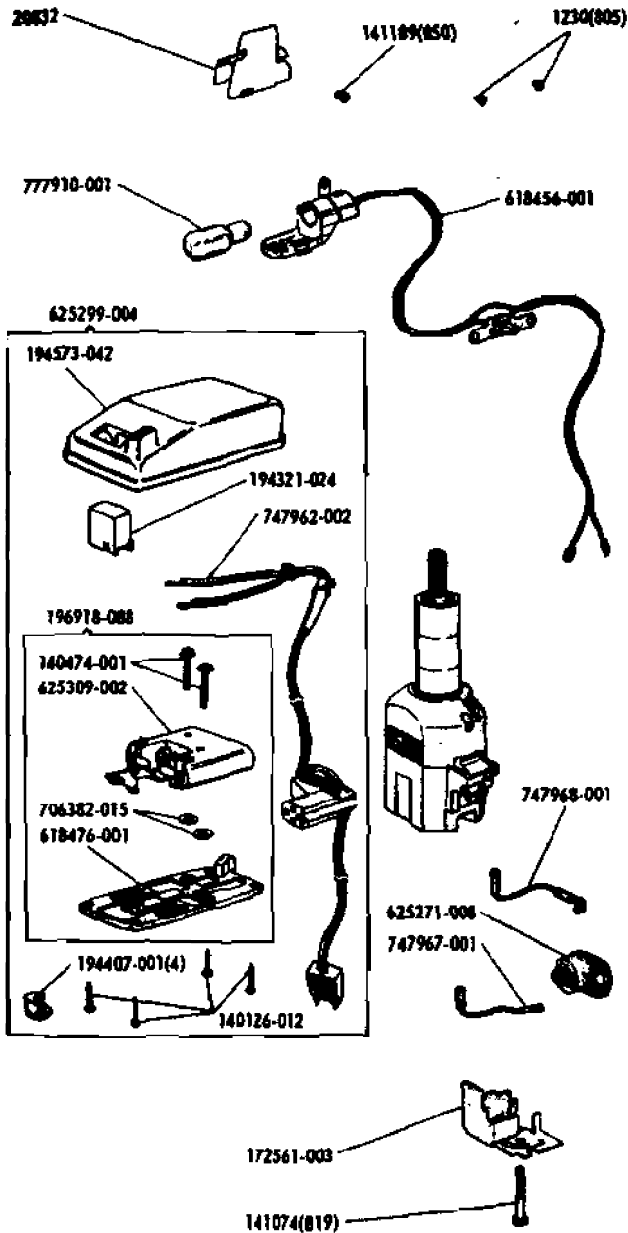

Machine No. 603E-16

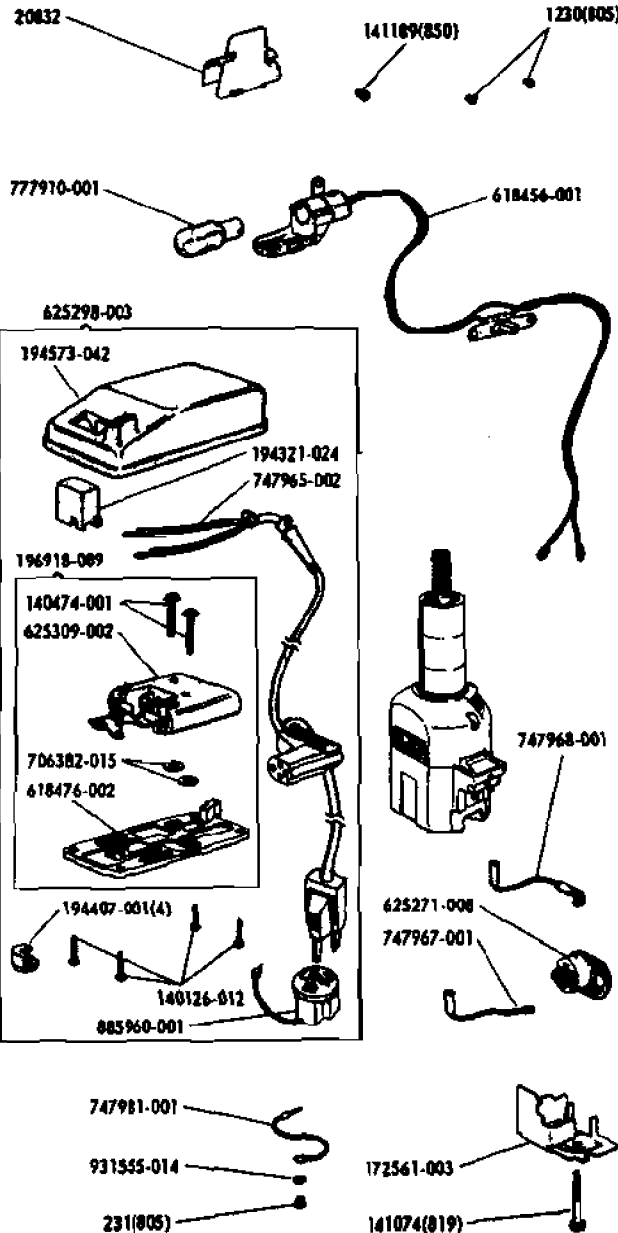

Machine No. 603E-14

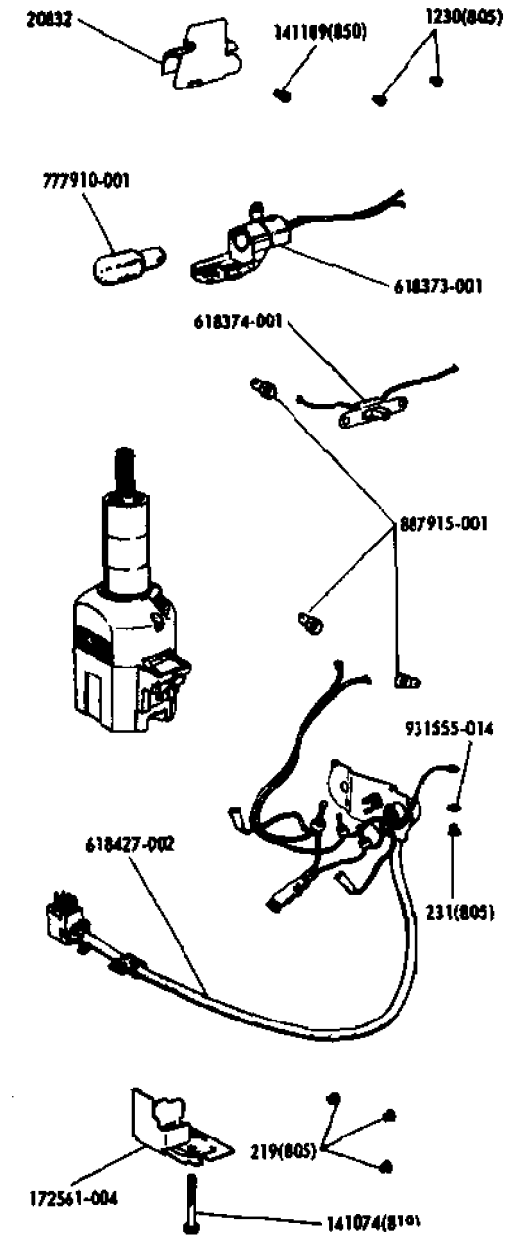

SUBJECT: PART NUMBER 163262-000, TOP COVER FOR MODEL 603E-11, 603E-14, 603E-16

PLEASE BE ADVISED THAT THE SUBJECT PART IS NO LONGER AVAILABLE AS A COMPLETE UNIT.
SHOULD YOU REQUIRE THIS PART, PLEASE ORDER COMPONENT PARTS. (SEE BELOW)

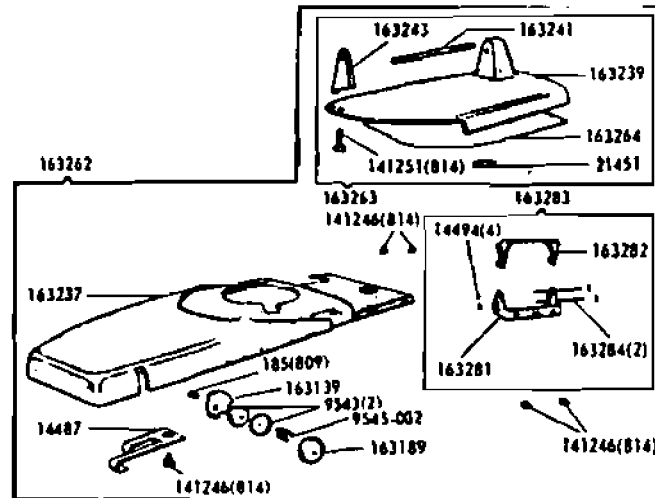

SUBJECT: PART NUMBER 161226-000, TUCKER

PLEASE BE ADVISED THAT ALL BACK ORDERS PRIOR TO MARCH 6, 1976 HAVE BEEN CANCELLED AS THE SUBJECT PART IS NO LONGER BEING MANUFACTURED. SHOULD YOU REQUIRE THIS PART, PLEASE REORDER PART NUMBER 160692-000 AS THIS IS A VALID SUBSTITUTION.